

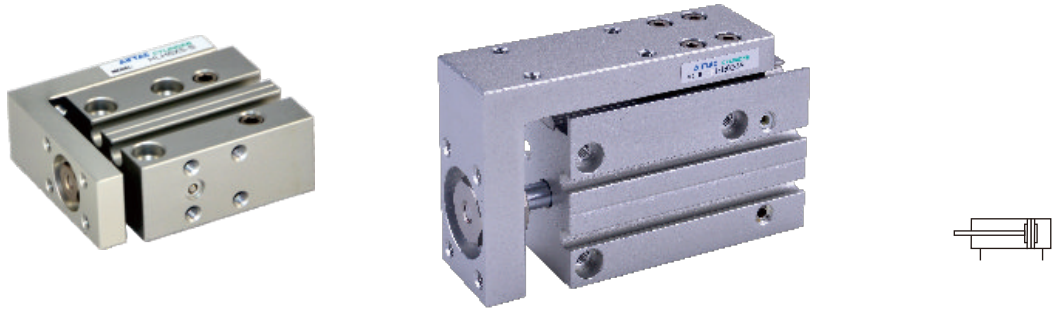

Compact slide cylinder—HLH Series

Bore size: $\Phi 6$, $\Phi 10$, $\Phi 16$, $\Phi 20$



Ordering code

HLH 20 × 30 S



① Model

HLH: Compact slide cylinder(Double acting type)

② Bore size

6 10 16 20

④ Magnet

S: With magnet

③ Stroke

Bore size (mm)	Standard stroke (mm)	Max.std stroke
6	5 10 15 20 25 30	30
10	5 10 15 20 25 30 40 50	50
16	5 10 15 20 25 30 40 50 60	60
20	5 10 15 20 25 30 40 50 60	60

[Note] Consult us for non-standard stroke.

Specification

Bore size(mm)	6	10	16	20
Guide rail width mm	5	7	9	12
Acting type	Double acting			
Fluid	Air(to be filtered by 40 μ m filter element)			
Operating pressure	22~100psi(0.15~0.7MPa)			
Proof pressure	175psi(1.2MPa)			
Temperature	-20~70 $^{\circ}$ C			
Speed range mm/s	50~500			
Allowable kinetic energy J	0.008	0.025	0.05	0.1
Stroke tolerance	+1.0 0			
Cushion type	Bumper			
Sensor switches	CMSH , DMSH(S)			
Port size	M5 \times 0.8			

Criteria for selection: Cylinder thrust

Unit: Newton(N)

Bore size	Rod size	Acting type	Pressure area(mm ²)	Operating pressure(psi)							
				15	30	45	60	75	90	105	
6	3	Double acting	Push-side	28.3	-	5.7	8.5	11.3	14.2	17.0	19.8
			Pull-side	21.2	-	4.2	6.4	8.5	10.6	12.7	14.8
10	4	Double acting	Push-side	78.5	7.9	15.7	23.6	31.4	39.3	47.1	55.0
			Pull-side	66.0	6.6	13.2	19.8	26.4	33.0	39.6	46.2
16	6	Double acting	Push-side	201.0	20.1	40.2	60.3	80.4	100.5	120.6	140.7
			Pull-side	172.7	17.3	34.5	51.8	69.1	86.4	103.6	120.9
20	8	Double acting	Push-side	314.0	31.4	62.8	94.2	125.6	157.0	188.4	219.8
			Pull-side	263.8	26.4	52.8	79.1	105.5	131.9	158.3	184.7



Model Selection Method

1. Select the bore size according to the thrust and practicality. Refer to the table on page 60.
2. Determine the selection conditions in order, starting from the upper row in the table below, and choose one of the selection graphs to be used.

Mounting position	Vertical			Horizontal								
Maximum speed(mm/s)	≤ 100	≤ 300	≤ 500	≤ 100			≤ 300			≤ 500		
Load offset l(mm)	-	-	-	50	100	200	50	100	200	50	100	200
Selection graph	(1)	(2)	(3)	(4)	(5)	(6)	(7)	(8)	(9)	(10)	(11)	(12)

L: Overhang
(the distance from the cylinder shaft centre to the load centre of gravity)

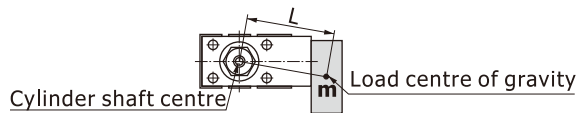

2.1) The relation between loading and overhang(Selection graphs)

Selection Graphs(1)

Maximum speed 100(mm/s) or less

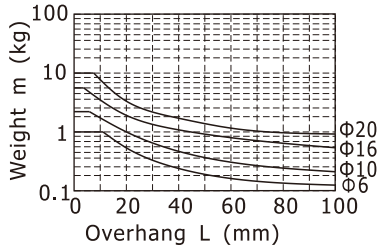

Selection Graphs(2)

Maximum speed 300(mm/s) or less

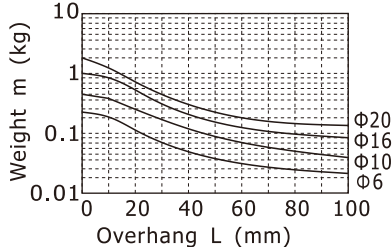

Selection Graphs(3)

Maximum speed 500(mm/s) or less

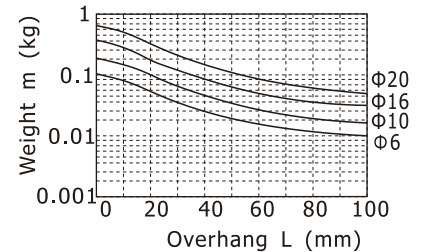

Selection Graphs(4)

Maximum speed 100(mm/s) or less
Load eccentricity 50mm

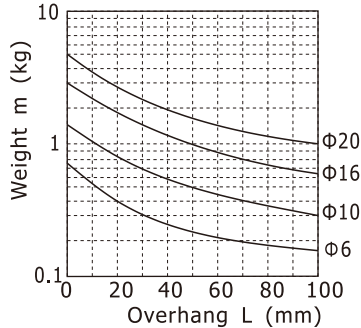

Selection Graphs(5)

Maximum speed 100(mm/s) or less
Load eccentricity 100mm

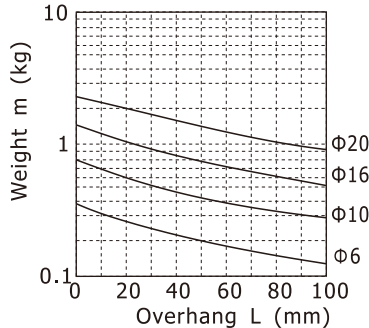

Selection Graphs(6)

Maximum speed 100(mm/s) or less
Load eccentricity 200mm

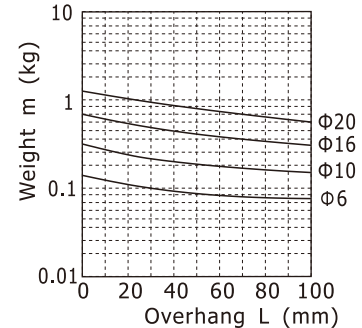

Selection Graphs(7)

Maximum speed 300(mm/s) or less
Load eccentricity 50mm

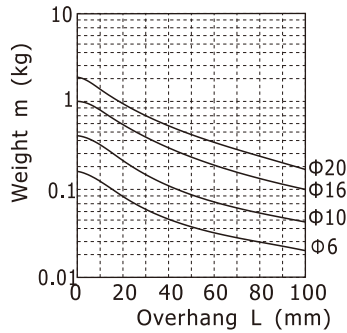

Selection Graphs(8)

Maximum speed 300(mm/s) or less
Load eccentricity 100mm

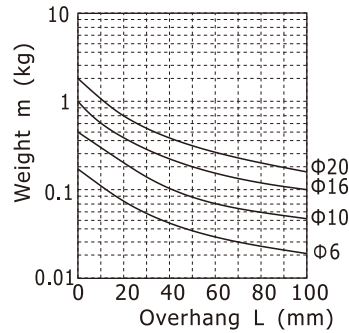

Selection Graphs(9)

Maximum speed 300(mm/s) or less
Load eccentricity 200mm

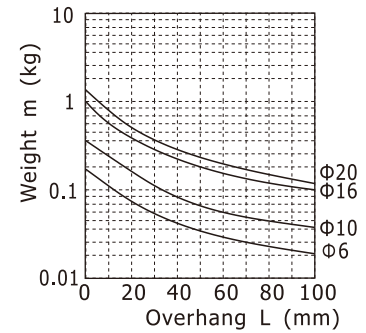

Selection Graphs(10)

Maximum speed 500(mm/s) or less
Load eccentricity 50mm

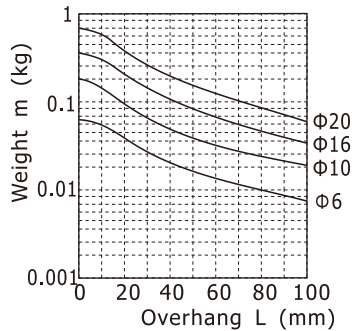

Selection Graphs(11)

Maximum speed 500(mm/s) or less
Load eccentricity 100mm

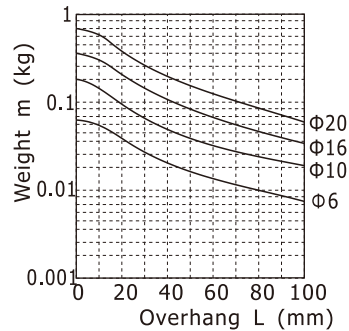

Selection Graphs(12)

Maximum speed 500(mm/s) or less
Load eccentricity 200mm

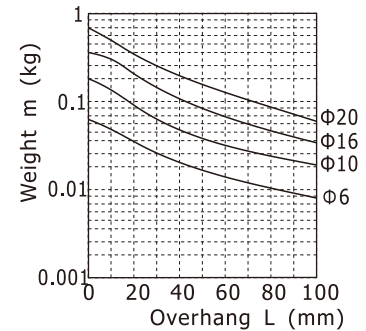

2.2) Selection Examples

Example ①: Mounting: Vertical
Maximum speed: 500mm/s
Overhang: 40mm
Load weight: 0.1Kg

Refer to Graph based on vertical mounting and a speed of 500mm/s.

In Graph , find the intersection of a 40mm overhang and load weight of 0.1Kg, which results in a selection of $\Phi 20$.

Example ②: Mounting: Horizontal
Maximum speed: 500mm/s
Load eccentricity: 50mm
Overhang: 30mm
Load weight: 0.1Kg

Refer to Graph based on horizontal mounting, a speed of 500mm/s and load eccentricity of 50mm.

In Graph , find the intersection of a 30mm overhang and load weight of 0.1Kg, which results in a selection of $\Phi 16$.

Installation and application

1. The actual loading and moment of cylinder must be less than it's allowable loading and moment:

1.1) The allowable moment of cylinder

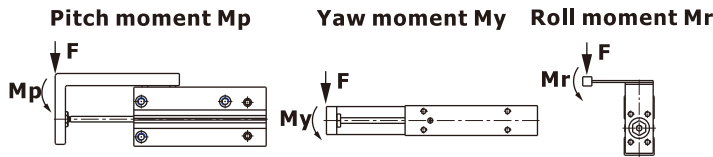

Allowable torque (Nm)	HLH6	HLH10	HLH16	HLH20
Pitch moment M_p	0.25	0.95	3.28	6.29
Yaw moment M_y	0.25	0.95	3.28	6.29
Roll moment M_r	0.41	1.49	3.45	6.61

1.2) When the cylinder is subjected to different type of moment, there will be different degree of shift in performance, please refer to the following table for details.

Table deflection due to pitch moment

Table deflection (arrow) when a load acts upon the section marked with the arrow at the full stroke of the compact slide.

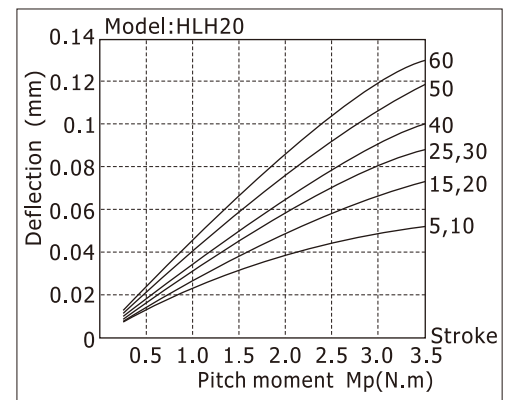
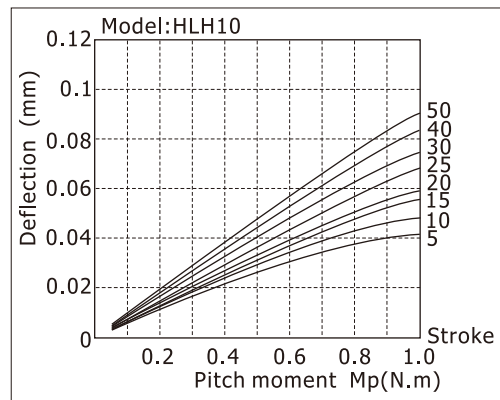
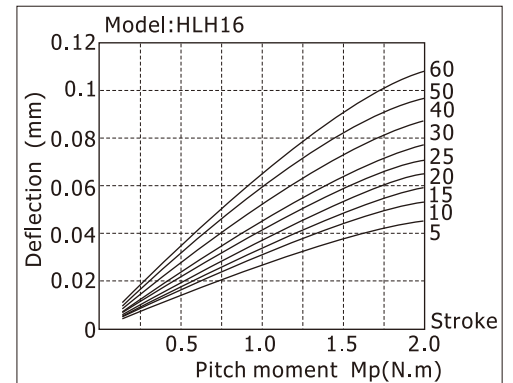
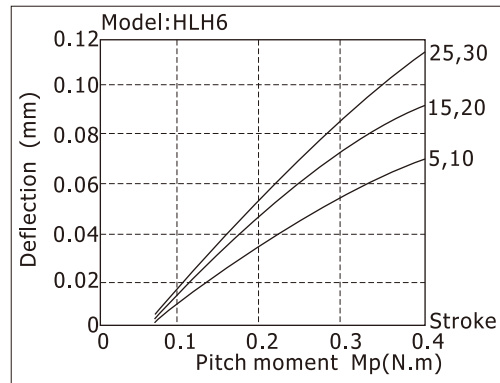
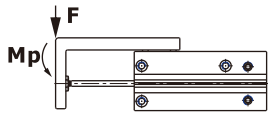

Table deflection due to yaw moment

Table deflection (arrow) when a load acts upon the section marked with the arrow at the full stroke of the compact slide.

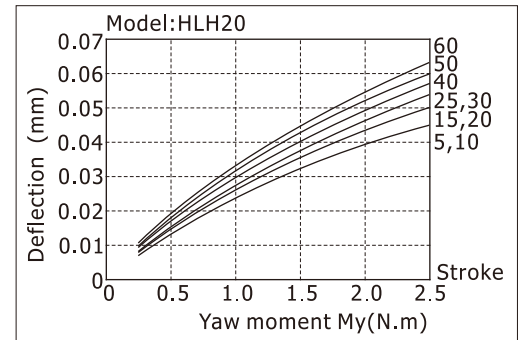
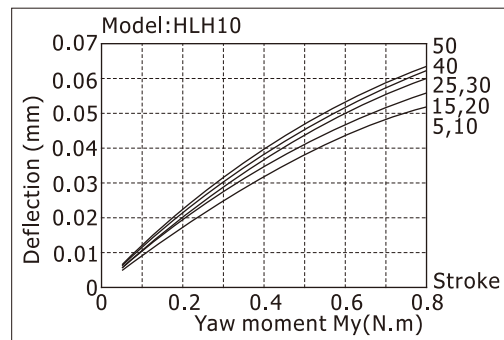
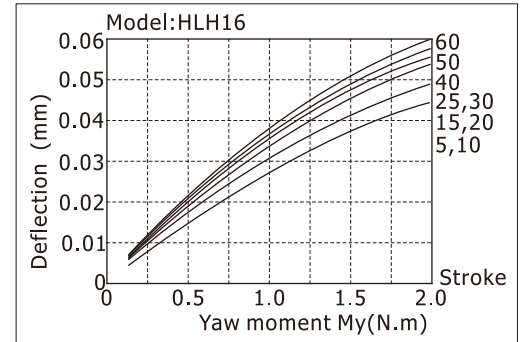
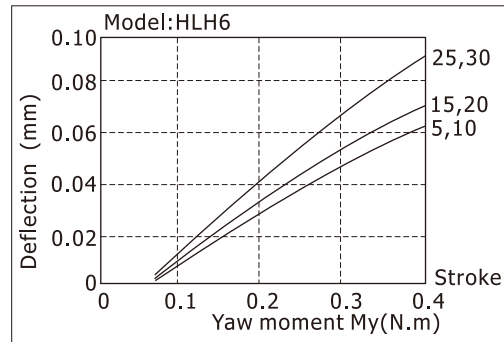
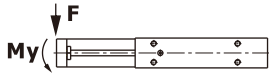
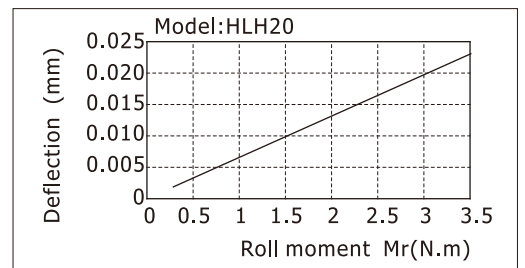
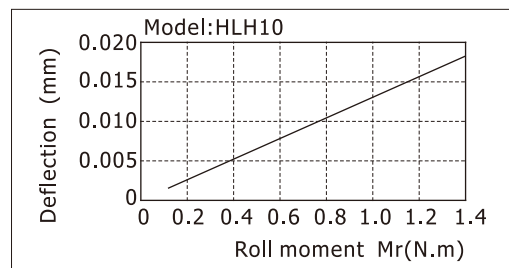
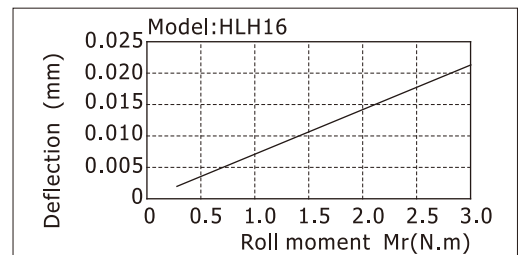
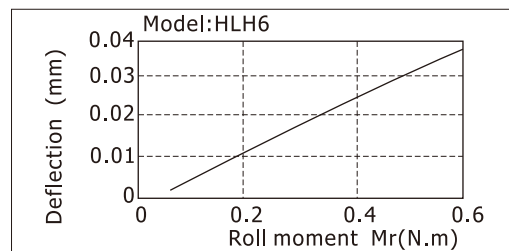
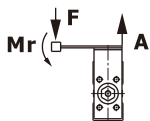

Table deflection due to roll moment

Table deflection (at A) when a load acts upon section F at the full stroke of the compact slide.



Compact slide cylinder

HLH Series

Bore size: $\Phi 6$, $\Phi 10$, $\Phi 16$, $\Phi 20$

2. The compact slide can be piped from 3 directions.
Confirm the pressure ports and operating direction. (See drawing right)

3. In compact slides with sensor switch, there is a danger of sensor switch malfunction if the mounting pitch is less than the dimensions shown in Table below. Be sure to allow at least the indicated interval.

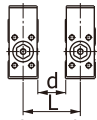
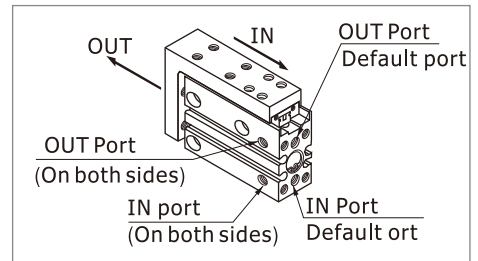

At least indicated interval (mm)/Model	HLH6	HLH10	HLH16	HLH20
d	5	5	10	15
L	21	25	35	47

4. When the output of the compact slide will be directly applied to the table, it should be applied along the rod axis.
(See drawing below.)

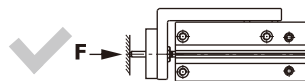

The loading and piston rod are coaxial

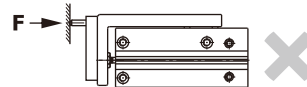

The loading and piston rod are offset

5. Be sure to use a flow control value, and adjust the speed to 500mm/s or less.

6. A compact slide can be mounted from 4 directions.

Don't exceed the max. fastening torque then tightening the mounting bolts.

Lateral Mounting(Through Holes)

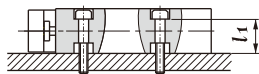

Model	Bolts	Max.fastening torque	L1
HLH6	M3×0.5	1.1(Nm)	12.7
HLH10	M4×0.7	2.5(Nm)	15.6
HLH16	M4×0.7	2.5(Nm)	20.6
HLH20	M5×0.8	5.1(Nm)	24.0

Lateral Mounting(Tapped Holes)

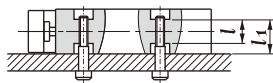

Model	Bolts	Max.fastening torque	L1	L
HLH6	M4×0.7	2.5(Nm)	12.7	9.4
HLH10	M5×0.8	5.1(Nm)	15.6	11.2
HLH16	M5×0.8	5.1(Nm)	20.6	16.2
HLH20	M6×1.0	8.1(Nm)	24.0	16.0

Axial Mounting(Tapped Holes)

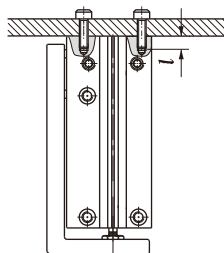

Model	Bolts	Max.fastening torque	L
HLH6	M3×0.5	1.1(Nm)	5
HLH10	M4×0.7	2.5(Nm)	6
HLH16	M4×0.7	2.5(Nm)	6
HLH20	M5×0.8	5.1(Nm)	8

Vertical Mounting(Tapped Holes)

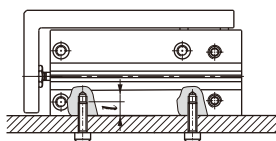

7. Work Piece Mounting

7.1) Work pieces can be mounted on 2 surfaces of the compact slide. When mounting a work piece, tighten the bolts properly at a torque value within the limiting range.

Front Mounting

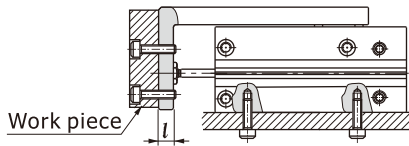

Model	Bolts	Max.fastening torque	L
HLH6	M3×0.5	1.1(Nm)	5.5
HLH10	M4×0.7	2.5(Nm)	7.5
HLH16	M4×0.7	2.5(Nm)	10
HLH20	M5×0.8	5.1(Nm)	11

Top Mounting

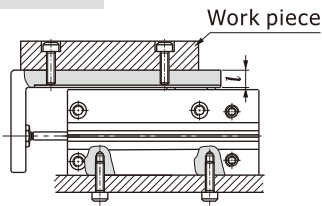

Model	Bolts	Max.fastening torque	L
HLH6	M3×0.5	1.1(Nm)	6.5
HLH10	M4×0.7	2.5(Nm)	8
HLH16	M4×0.7	2.5(Nm)	9
HLH20	M5×0.8	5.1(Nm)	9.5

7.2) Since the table is supported by the linear guide, take care not to apply strong impact or large moment to the guide section.

7.3) Hold the slide when fastening work pieces with bolts, If the body is held while tightening bolts, excessive moment may damage guide section.

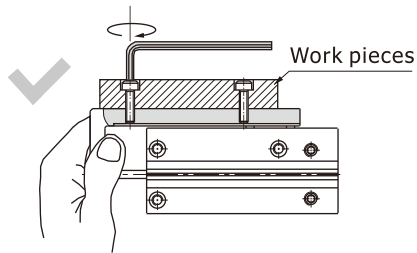

Hold the slide and fasten the bolt

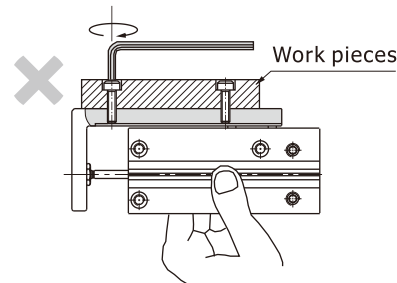

Hold the body and fasten the bolt

Compact slide cylinder

AIRTAC

HLH Series

Bore size: $\Phi 6$, $\Phi 10$, $\Phi 16$, $\Phi 20$

Dimensions

HLH6

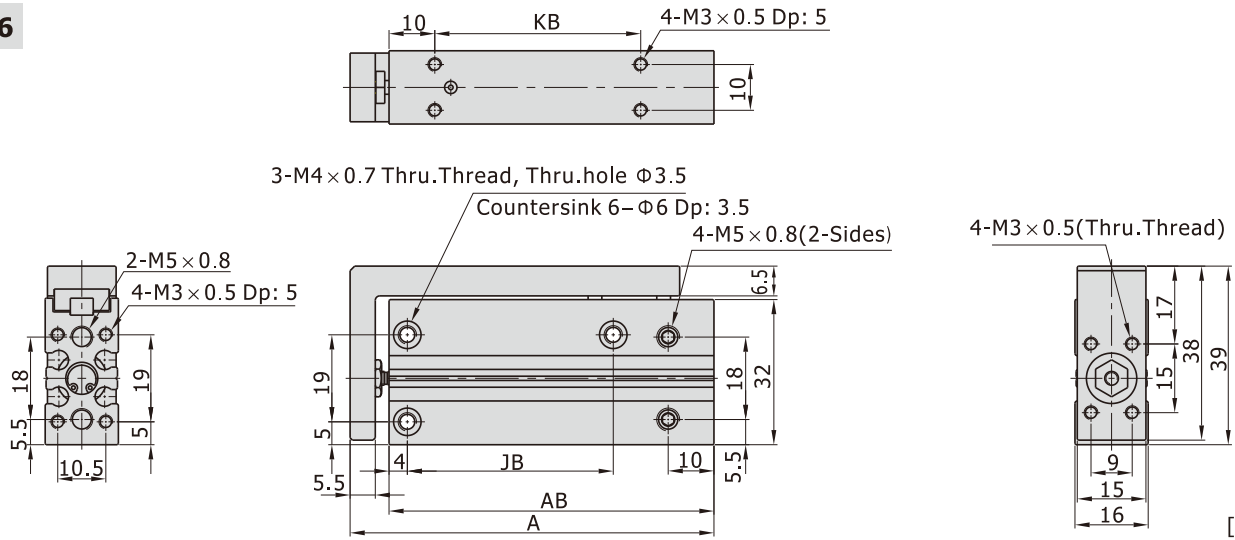

[Unit: mm]

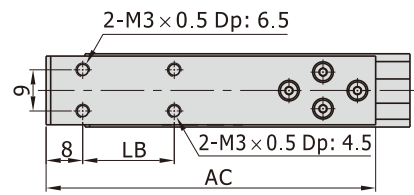

Stroke\Item	A	AB	AC	JB	KB	LB
5	44.5	36	42	14	10	10
10	49.5	41	42	14	15	10
15	54.5	46	52	24	20	20
20	59.5	51	52	24	25	20
25	64.5	56	62	30	30	30
30	69.5	61	62	30	35	30

HLH10

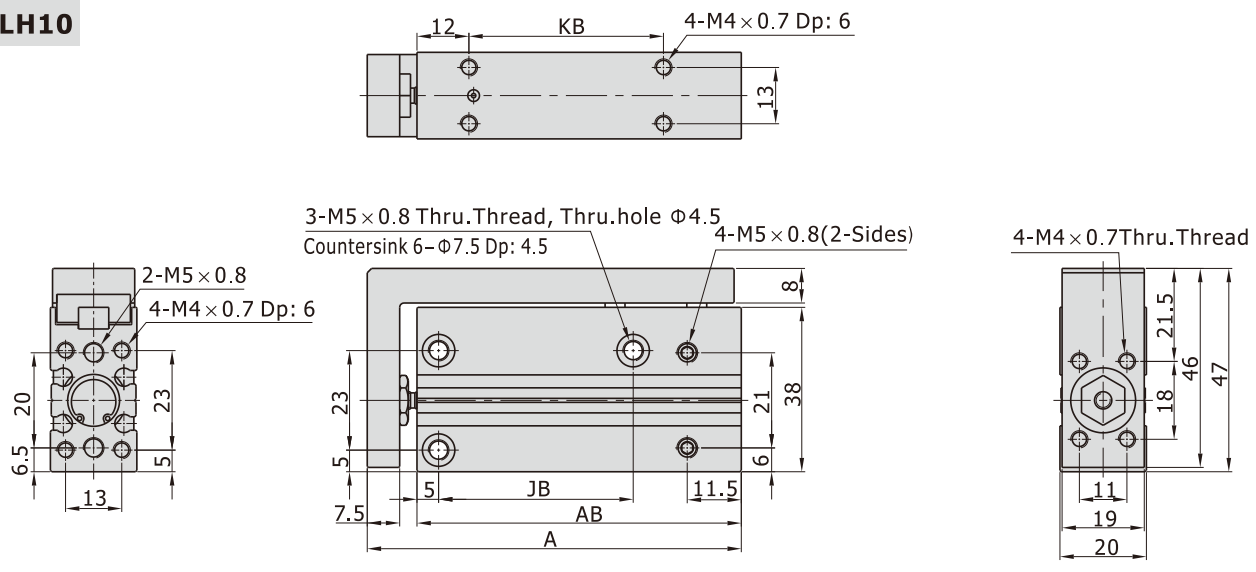

[Unit: mm]

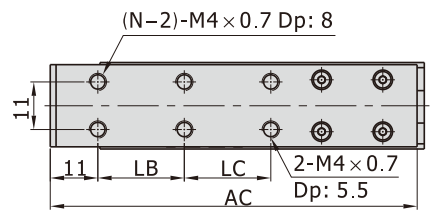

Stroke\Item	A	AB	AC	JB	KB	LB	LC	N
5	51.5	40	50	14	10	10	-	4
10	56.5	45	55	14	15	10	-	4
15	61.5	50	60.5	24	20	20	-	4
20	66.5	55	63	24	25	20	-	4
25	71.5	60	70.5	30	30	30	-	4
30	76.5	65	75.5	30	35	30	-	4
40	86.5	75	85.5	45	45	20	20	6
50	96.5	85	93	55	55	25	25	6



Compact slide cylinder

HLH Series

Bore size: $\Phi 6$, $\Phi 10$, $\Phi 16$, $\Phi 20$

HLH16

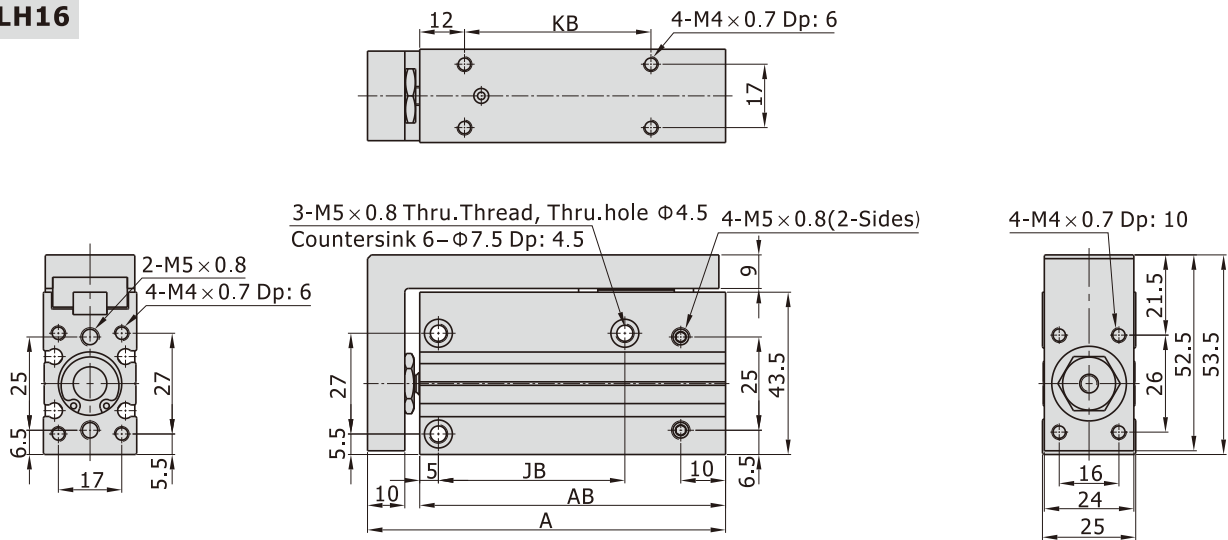

[Unit: mm]

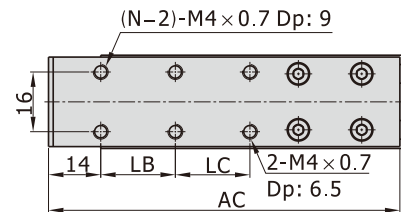

Stroke\Item	A	AB	AC	JB	KB	LB	LC	N
5	61	47	60	20	15	10	-	4
10	66	52	64.5	20	20	10	-	4
15	71	57	69.5	30	25	20	-	4
20	76	62	75	30	30	20	-	4
25	81	67	80	40	35	30	-	4
30	86	72	84.5	40	40	30	-	4
40	96	82	95	50	50	20	20	6
50	106	92	104.5	60	60	25	25	6
60	116	102	114.5	60	70	30	30	6

HLH20

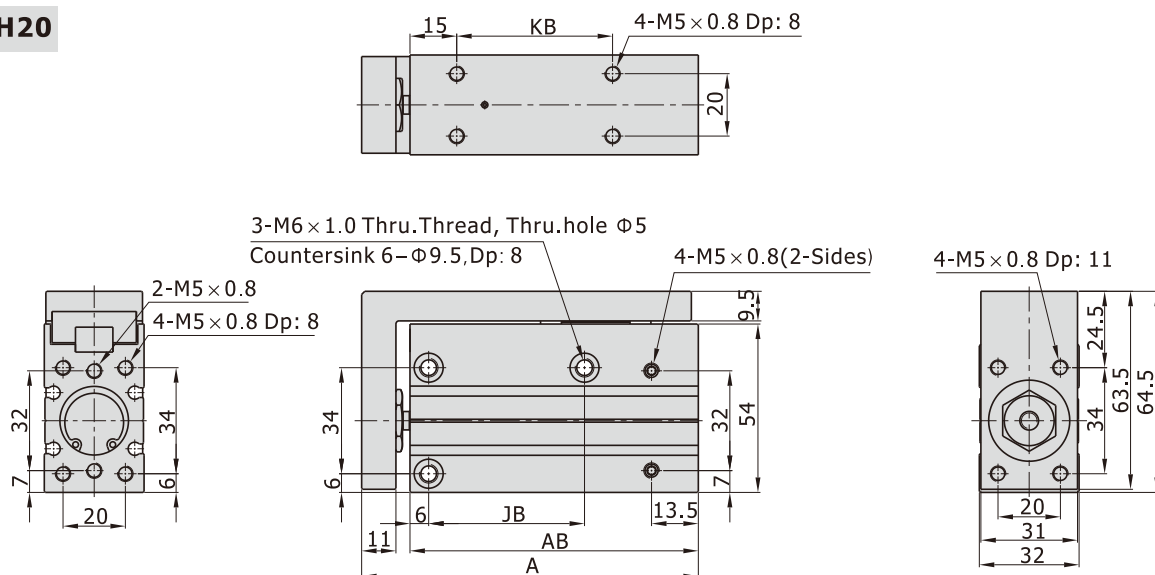

[Unit: mm]

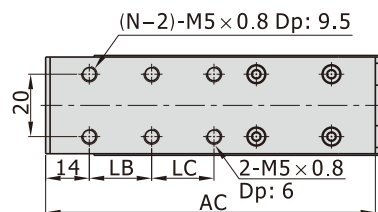

Stroke\Item	A	AB	AC	JB	KB	LB	LC	N
5	73	57.5	72	20	15	10	-	4
10	78	62.5	72	20	20	10	-	4
15	83	67.5	82	25	25	20	-	4
20	88	72.5	82	25	30	20	-	4
25	93	77.5	92	40	35	30	-	4
30	98	82.5	92	40	40	30	-	4
40	108	92.5	101.5	50	50	20	20	6
50	118	102.5	113.5	70	60	25	25	6
60	128	112.5	122.5	70	70	30	30	6